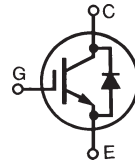


## High Voltage, High Gain BIMOSFET™ Monolithic Bipolar MOS Transistor

## IXBH16N170 IXBT16N170



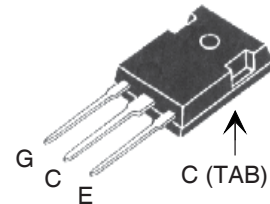
$$V_{CES} = 1700V$$

$$I_{C90} = 16A$$

$$V_{CE(sat)} \leq 3.3V$$

Symbol	Test Conditions	Maximum Ratings	
$V_{CES}$	$T_C = 25^\circ C$ to $150^\circ C$	1700	V
$V_{CGR}$	$T_J = 25^\circ C$ to $150^\circ C$ , $R_{GE} = 1M\Omega$	1700	V
$V_{GES}$	Continuous	$\pm 20$	V
$V_{GEM}$	Transient	$\pm 30$	V
$I_{C25}$	$T_C = 25^\circ C$	40	A
$I_{C90}$	$T_C = 90^\circ C$	16	A
$I_{CM}$	$T_C = 25^\circ C$ , 1ms	120	A
<b>SSOA</b>	$V_{GE} = 15V$ , $T_{VJ} = 125^\circ C$ , $R_G = 22\Omega$	$I_{CM} = 40$	A
<b>(RBSOA)</b>	Clamped inductive load	$V_{CES} \leq 1350$	V
$P_C$	$T_C = 25^\circ C$	250	W
$T_J$		-55 ... +150	$^\circ C$
$T_{JM}$		150	$^\circ C$
$T_{stg}$		-55 ... +150	$^\circ C$
$T_L$	1.6mm (0.062 in.) from case for 10s	300	$^\circ C$
$T_{SOLD}$	Plastic body for 10 seconds	260	$^\circ C$
$M_d$	Mounting torque (TO-247)	1.13/10	Nm/lb.in.
<b>Weight</b>	TO-247	6	g
	TO-268	4	g

### TO-247 (IXBH)



### TO-268 (IXBT)



G = Gate      C = Collector  
E = Emitter    TAB = Collector

### Features

- High blocking voltage
- International standard packages
- Low conduction losses

### Advantages

- Low gate drive requirement
- High power density

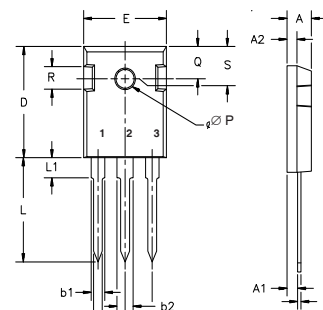
### Applications:

- Switched-mode and resonant-mode power supplies
- Uninterruptible power supplies (UPS)
- Laser generator
- Capacitor discharge circuit
- AC switches

Symbol	Test Conditions ( $T_J = 25^\circ C$ unless otherwise specified)	Characteristic Values		
		Min.	Typ.	Max.
$BV_{CES}$	$I_C = 250\mu A$ , $V_{GE} = 0V$	1700		V
$V_{GE(th)}$	$I_C = 250\mu A$ , $V_{CE} = V_{GE}$	3.0		5.5 V
$I_{CES}$	$V_{CE} = 0.8 \cdot V_{CES}$ $V_{GE} = 0V$ $T_J = 125^\circ C$			50 $\mu A$ 2 mA
$I_{GES}$	$V_{CE} = 0V$ , $V_{GE} = \pm 20V$			$\pm 100$ nA
$V_{CE(sat)}$	$I_C = 16A$ , $V_{GE} = 15V$ , Note 1  $T_J = 125^\circ C$		3.2	3.3 V V

Symbol	Test Conditions	Characteristic Values		
		Min.	Typ.	Max.
$g_{fS}$	$I_C = 16A, V_{CE} = 10V$ , Note 1	8.5	14	S
$C_{ies}$	$V_{CE} = 25V, V_{GE} = 0V, f = 1MHz$		1960	pF
$C_{oes}$			85	pF
$C_{res}$			24	pF
$Q_g$	$I_C = 16A, V_{GE} = 15V, V_{CE} = 0.5 \cdot V_{CES}$		72	nC
$Q_{ge}$			12	nC
$Q_{gc}$			25	nC
$t_{d(on)}$	<b>Resistive Switching times, <math>T_J = 25^\circ C</math></b> $I_C = 16A, V_{GE} = 15V$ $V_{CE} = 850V, R_G = 22\Omega$		38	ns
$t_r$			101	ns
$t_{d(off)}$			125	ns
$t_f$			480	ns
$t_{d(on)}$	<b>Resistive Switching times, <math>T_J = 125^\circ C</math></b> $I_C = 16A, V_{GE} = 15V$ $V_{CE} = 850V, R_G = 22\Omega$		37	ns
$t_r$			183	ns
$t_{d(off)}$			235	ns
$t_f$			705	ns
$R_{thJC}$			0.50	$^\circ C/W$
$R_{thCS}$		0.25		$^\circ C/W$

### TO-247 (IXBH) Outline



Terminals: 1 - Gate  
2 - Drain  
3 - Source  
Tab - Drain

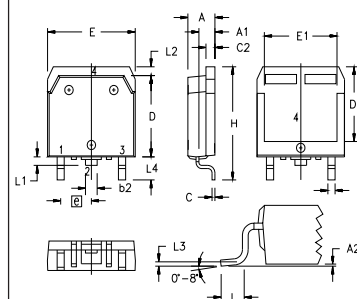
Dim.	Millimeter		Inches	
	Min.	Max.	Min.	Max.
A	4.7	5.3	.185	.209
A <sub>1</sub>	2.2	2.54	.087	.102
A <sub>2</sub>	2.2	2.6	.059	.098
b	1.0	1.4	.040	.055
b <sub>1</sub>	1.65	2.13	.065	.084
b <sub>2</sub>	2.87	3.12	.113	.123
C	.4	.8	.016	.031
D	20.80	21.46	.819	.845
E	15.75	16.26	.610	.640
e	5.20	5.72	0.205	0.225
L	19.81	20.32	.780	.800
L <sub>1</sub>		4.50		.177
∅P	3.55	3.65	.140	.144
Q	5.89	6.40	0.232	0.252
R	4.32	5.49	.170	.216
S	6.15	BSC	.242	BSC

### Reverse Diode

Symbol	Test Conditions	Characteristic Values		
		Min.	Typ.	Max.
$V_F$	$I_F = 16A, V_{GE} = 0V$			2.6 V
$t_{rr}$	$I_F = 8A, V_{GE} = 0V, -di_F/dt = 100A/\mu s$ $V_R = 100V, V_{GE} = 0V$		1.32	$\mu s$
$I_{RM}$			26	A

Note 1: Pulse test,  $t \leq 300\mu s$ , duty cycle,  $d \leq 2\%$ .

### TO-268 (IXBT) Outline

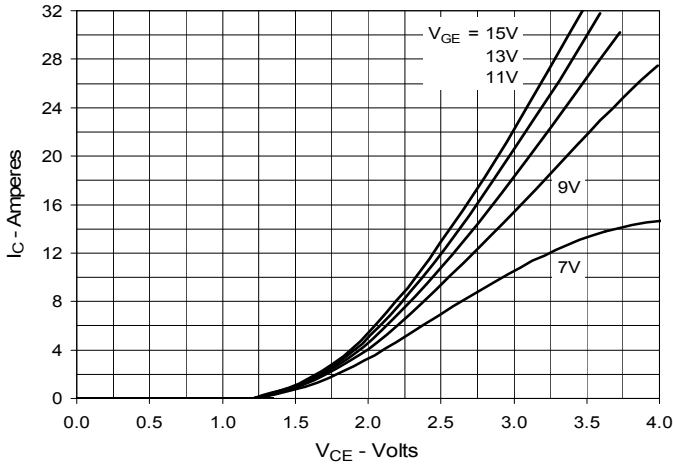


SYM	INCHES		MILLIMETERS	
	MIN	MAX	MIN	MAX
A	.193	.201	4.90	5.10
A1	.106	.114	2.70	2.90
A2	.001	.010	0.02	0.25
b	.045	.057	1.15	1.45
b2	.075	.083	1.90	2.10
C	.016	.026	0.40	0.65
C2	.057	.063	1.45	1.60
D	.543	.551	13.80	14.00
D1	.488	.500	12.40	12.70
E	.624	.632	15.85	16.05
E1	.524	.535	13.30	13.60
e	.215 BSC		5.45 BSC	
H	.736	.752	18.70	19.10
L	.094	.106	2.40	2.70
L1	.047	.055	1.20	1.40
L2	.039	.045	1.00	1.15
L3	.010 BSC		0.25 BSC	
L4	.150	.161	3.80	4.10

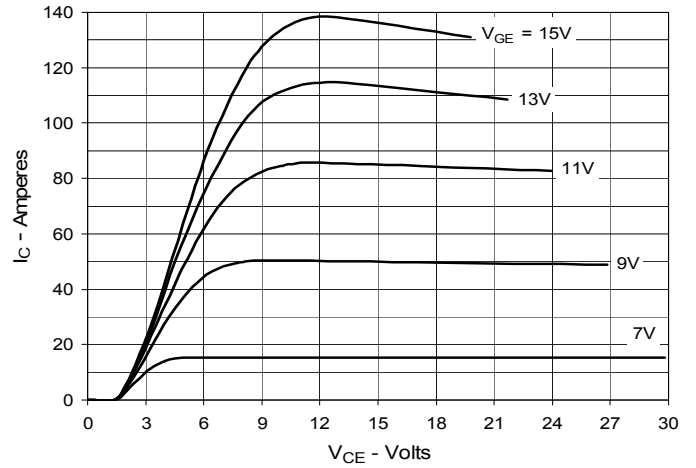
IXYS reserves the right to change limits, test conditions and dimensions.

IXYS MOSFETs and IGBTs are covered 4,835,592 4,931,844 5,049,961 5,237,481 6,162,665 6,404,065 B1 6,683,344 6,727,585 7,005,734 B2 7,157,338B2  
by one or more of the following U.S. patents: 4,850,072 5,017,508 5,063,307 5,381,025 6,259,123 B1 6,534,343 6,710,405 B2 6,759,692 7,063,975 B2  
4,881,106 5,034,796 5,187,117 5,486,715 6,306,728 B1 6,583,505 6,710,463 6,771,478 B2 7,071,537

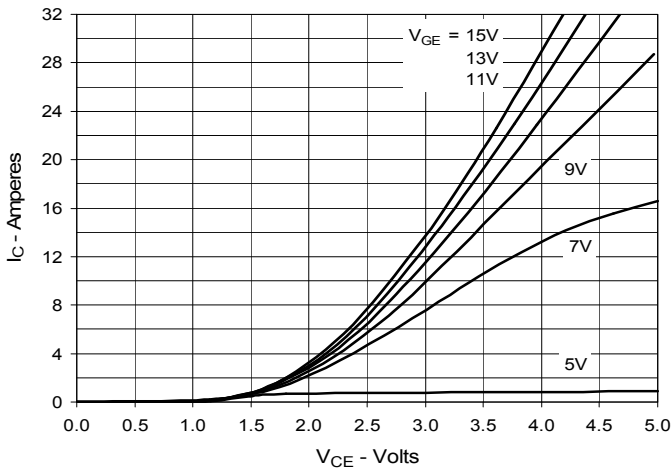
**Fig. 1. Output Characteristics @ 25°C**



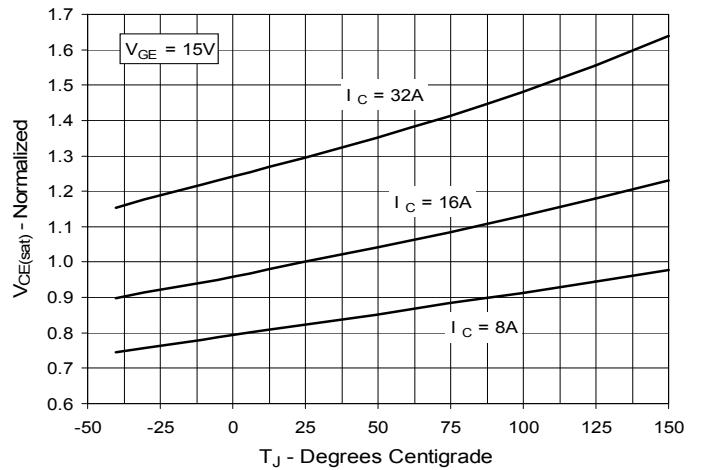
**Fig. 2. Extended Output Characteristics @ 25°C**



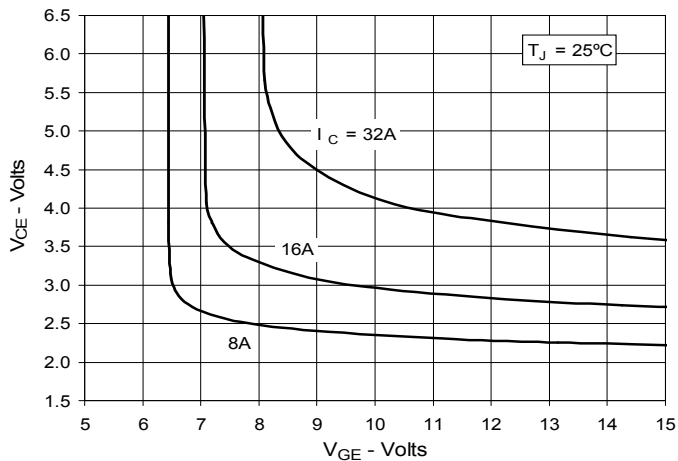
**Fig. 3. Output Characteristics @ 125°C**



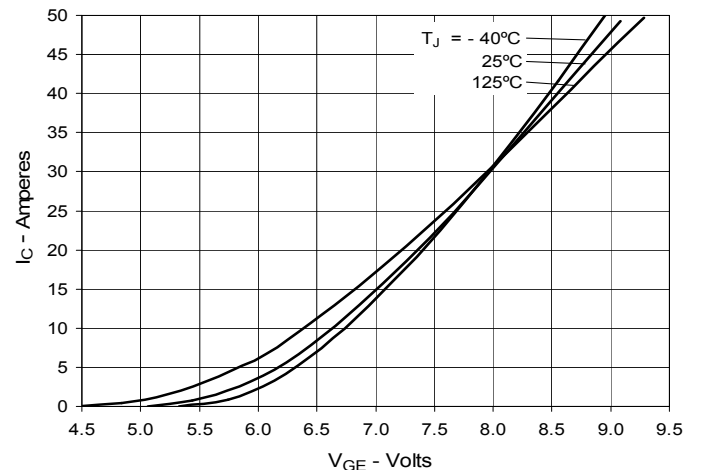
**Fig. 4. Dependence of  $V_{CE(sat)}$  on Junction Temperature**



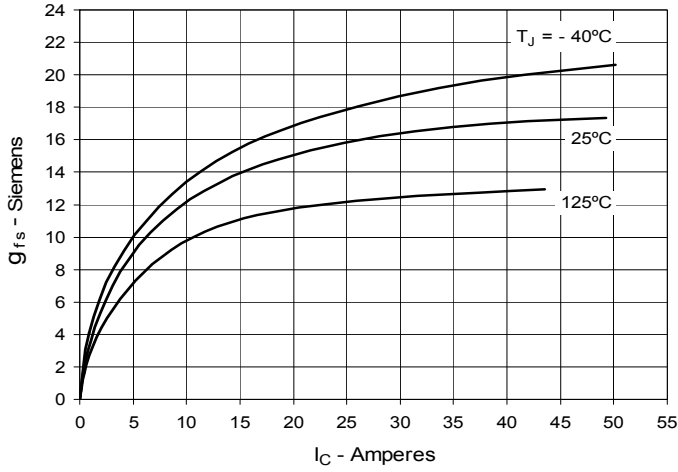
**Fig. 5. Collector-to-Emitter Voltage vs. Gate-to-Emitter Voltage**



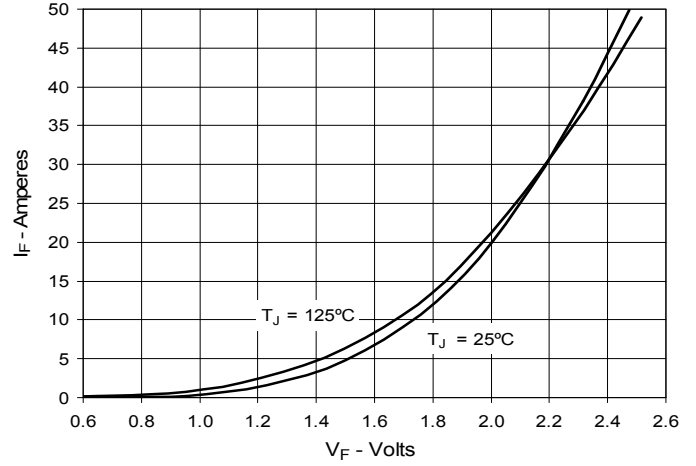
**Fig. 6. Input Admittance**



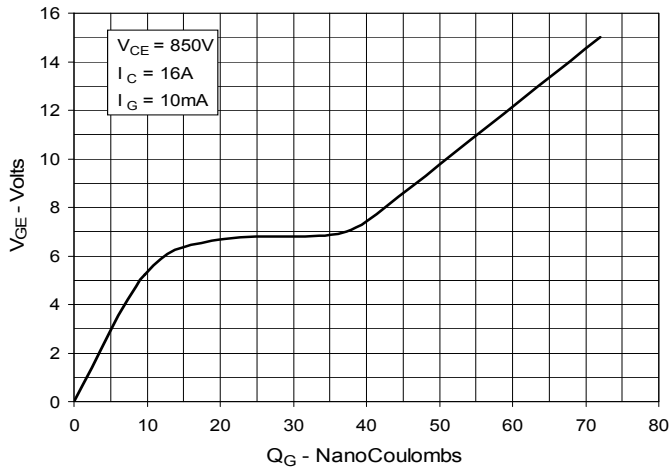
**Fig. 7. Transconductance**



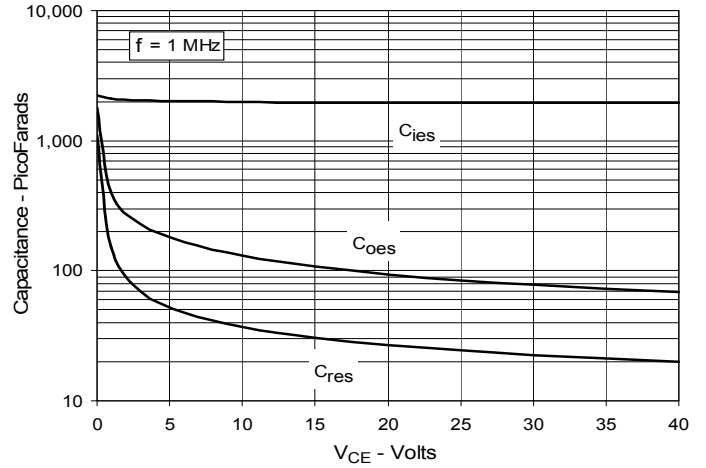
**Fig. 8. Forward Voltage Drop of Intrinsic Diode**



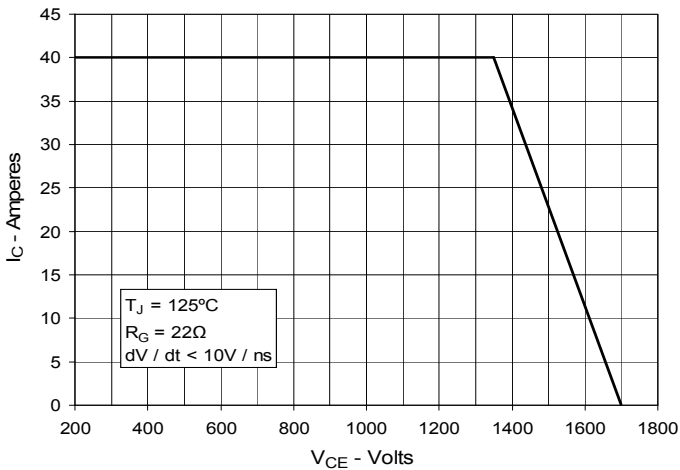
**Fig. 9. Gate Charge**



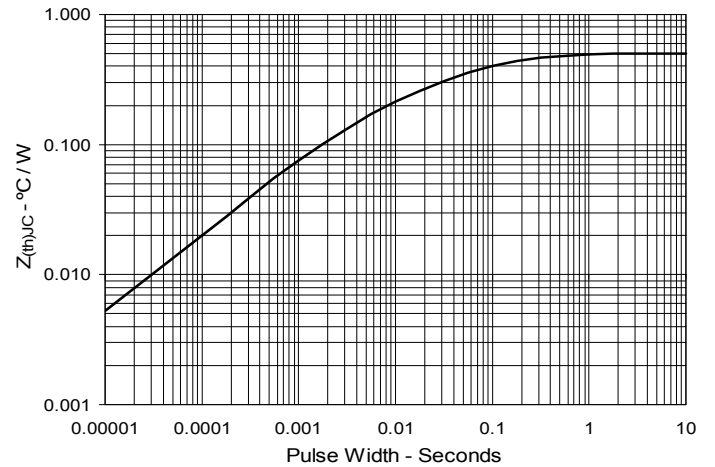
**Fig. 10. Capacitance**



**Fig. 11. Reverse-Bias Safe Operating Area**

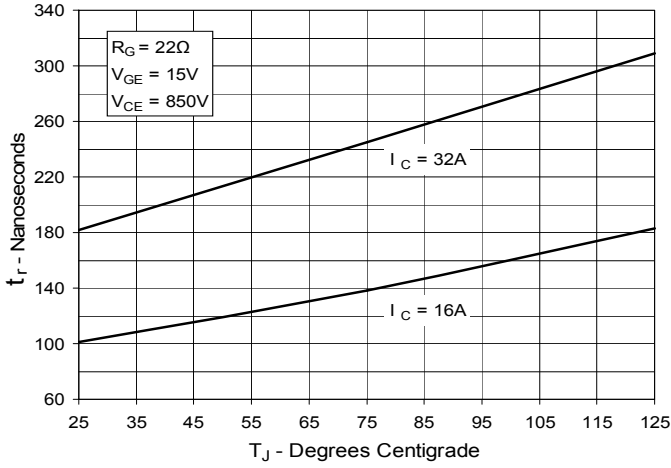


**Fig. 12. Maximum Transient Thermal Impedance**

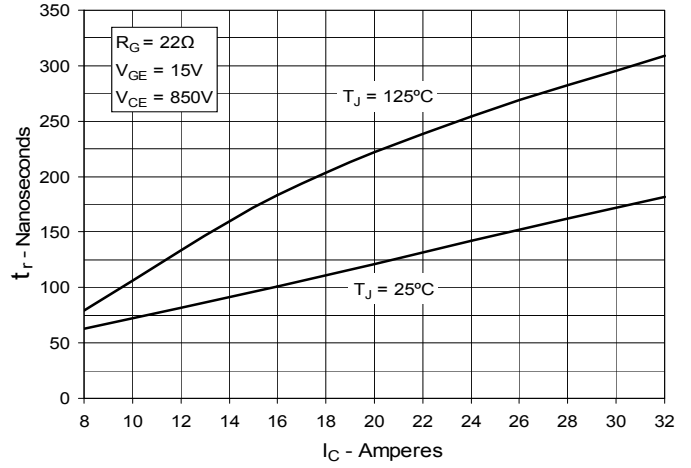


IXYS reserves the right to change limits, test conditions and dimensions.

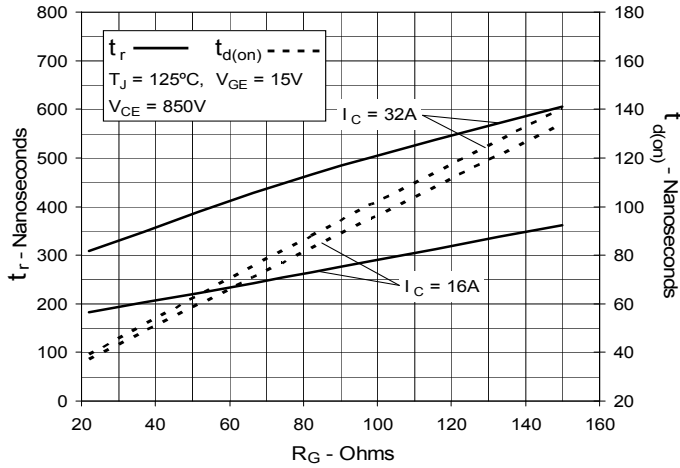
**Fig. 13. Resistive Turn-on Rise Time vs. Junction Temperature**



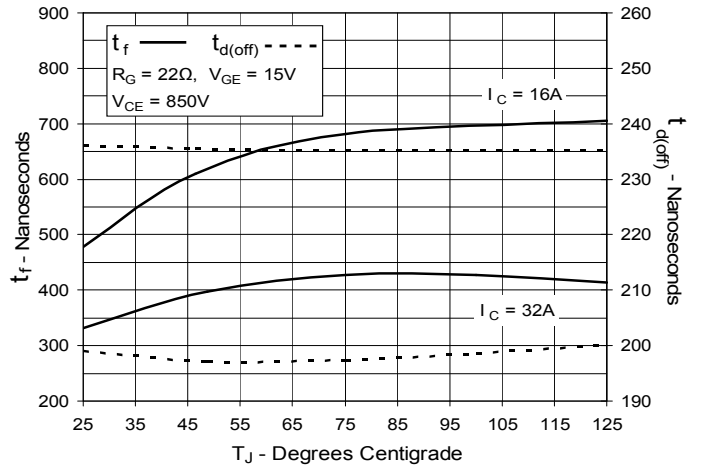
**Fig. 14. Resistive Turn-on Rise Time vs. Drain Current**



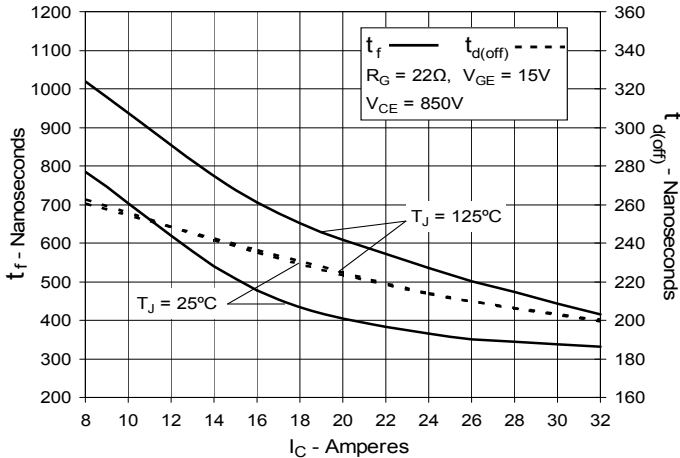
**Fig. 15. Resistive Turn-on Switching Times vs. Gate Resistance**



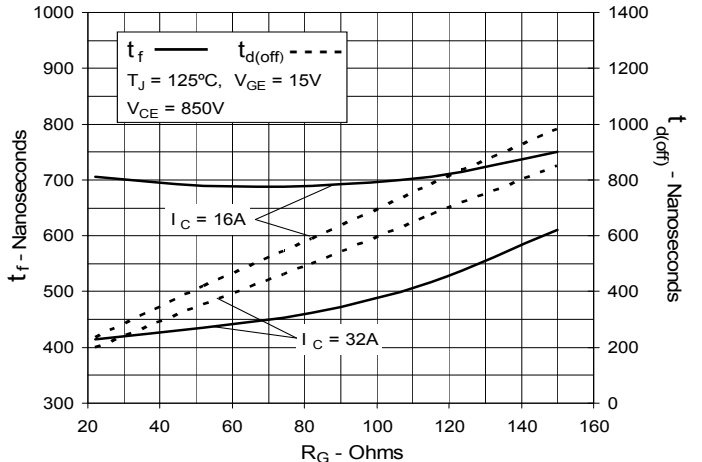
**Fig. 16. Resistive Turn-off Switching Times vs. Junction Temperature**



**Fig. 17. Resistive Turn-off Switching Times vs. Drain Current**



**Fig. 18. Resistive Turn-off Switching Times vs. Gate Resistance**





---

Disclaimer Notice - Information furnished is believed to be accurate and reliable. However, users should independently evaluate the suitability of and test each product selected for their own applications. Littelfuse products are not designed for, and may not be used in, all applications. Read complete Disclaimer Notice at [www.littelfuse.com/disclaimer-electronics](http://www.littelfuse.com/disclaimer-electronics).